



PARTS LIST FOR

MH-0075-0M10

MH-0135-0M10

MH-0190-0M10

MH-0215-0M10

This Parts Listing has been compiled for your benefit. You can be assured your Mi-T-M Space Heater was constructed and designed with quality and performance in mind. Each component has been rigorously tested to insure the highest level of acceptance.

The contents of this Parts Listing are based on the latest product information available at the time of publication. Mi-T-M reserves the right to make changes in price, color, materials, equipment, specifications or models at any time without notice.

WARNING

THIS IS A PROFESSIONAL SPACE HEATER. CAUTION SHOULD BE OBSERVED WHEN USING OR REPAIRING THIS UNIT! READ AND FOLLOW THE SAFETY WARNINGS LISTED BELOW BEFORE ATTEMPTING ANY REPAIRS ON THIS SPACE HEATER!

SAFETY WARNINGS

1. NEVER alter or modify the equipment. Use only genuine Mi-T-M parts for repair of your space heater. Failure to do so can cause hazardous operating conditions and will VOID warranty.
2. Be thoroughly familiar with controls.
3. Before servicing the unit, turn unit off, and allow the unit to cool down. Do not make repairs while the unit is running. Service in a clean, dry, flat area. Block the wheels to prevent the unit from moving. Be especially careful to properly dispose of any flammable materials.

Table of Contents

SPECIFICATIONS.....3
FRAME ASSEMBLY4

SPECIFICATIONS

MODEL NUMBER	MH-0075-0M10	MH-0135-0M10	MH-0190-0M10	MH-0215-0M10
Output Rating (BTU/Hr):	75,000	135,000	190,000	215,000
Tank Capacity (gal)	5.0	10.0	13.0	13.0
Consumption (gal. per Hr)	.56	1.00	1.42	1.63
Pump Pressure (PSI):	4.0	5.0	7.5	9.0
Electric Requirements:	120V / 60HZ			
Amperage (normal run)	1.5	3.6	2.7	2.8
Net Weight (Lbs):	28	54	61	64
Size (L x W x H)	30" x 12" x 15"	39" x 23" x 26"	43" x 24" x 26"	43" x 24" x 26"

FRAME ASSEMBLY

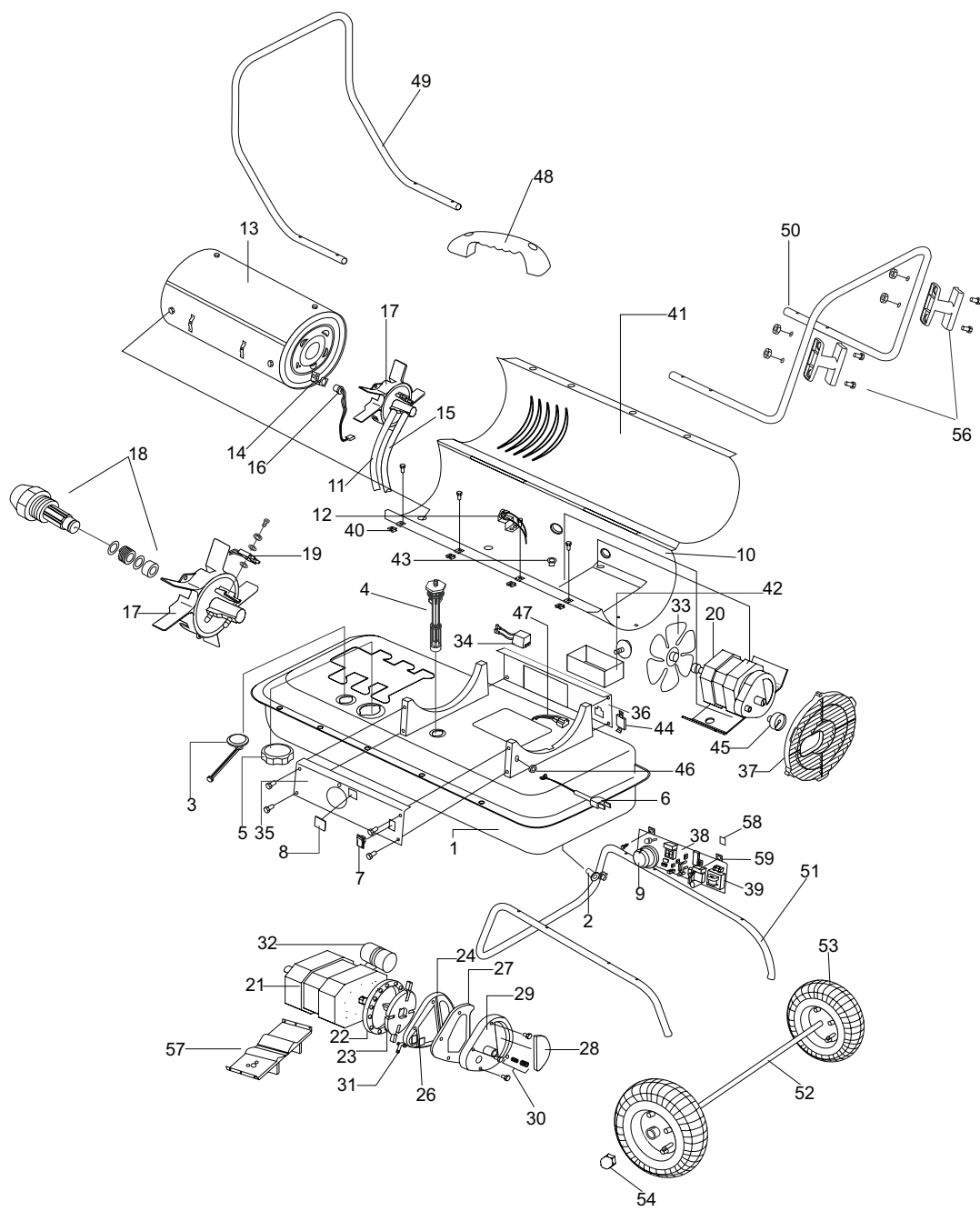

MIH-0075_0135_0190_0215-0M10 051115

FRAME ASSEMBLY

ITEM NO.	ITEM DESCRIPTION	PART NO.	ITEM NO.	ITEM DESCRIPTION	PART NO.	ITEM NO.	ITEM DESCRIPTION	PART NO.
1	FUEL TANK ASSEMBLY (75K)	68-3252	18	NOZZLE KIT (75K)	68-3031	39	FUSE	68-3068
-	FUEL TANK ASSEMBLY (135K)	68-3253	-	NOZZLE KIT (135K)	68-3251	40	CLIP NUT	68-3069
-	FUEL TANK ASSEMBLY (190K, 215K)	68-3254	-	NOZZLE KIT (190K)	68-3033	41	UPPER SHELL - (75K)	68-3077
2	DRAIN PLUG	68-3001	-	NOZZLE KIT (215K)	68-3034	-	UPPER SHELL - (135K)	68-3079
3	FUEL GAUGE ASSEMBLY (75K)	68-3002	19	SPARK PLUG (75K)	68-3035	-	UPPER SHELL - (190K)	68-3081
-	FUEL GAUGE ASSEMBLY (135K, 190K)	68-3219	-	SPARK PLUG (135K, 190K, 215K)	68-3036	-	UPPER SHELL - (215K)	68-3083
-	FUEL GAUGE ASSEMBLY (215K)	68-3220	20	MOTOR AND PUMP ASSEMBLY (75K)	68-3230	42	STORAGE BOX (135K, 190K, 215K)	68-3215
4	FUEL FILTER ASSEMBLY (75K)	68-3004	-	MOTOR AND PUMP ASSEMBLY (135K)	68-3231	43	BUSHING GROMMET	68-3070
-	FUEL FILTER ASSEMBLY (135K, 190K, 215K)	68-3005	-	MOTOR AND PUMP ASSEMBLY (190K)	68-3232	44	SOCKET COVER	N/A
5	FUEL CAP ASSEMBLY	68-3255	-	MOTOR AND PUMP ASSEMBLY (215K)	68-3233	45	AIR PRESSURE GAUGE	68-3071
6	POWER CORD (75K)	68-3006	21	MOTOR	N/A	46	CORD BUSHING (75K)	68-3072
-	POWER CORD (135K, 190K, 215K)	68-3007	22	PUMP BODY (75K, 135K)	68-3041	-	CORD BUSHING (135K, 190K, 215K)	68-3073
7	POWER SWITCH	68-3008	-	PUMP BODY (190K, 215K)	68-3042	47	ELECTRIC OUTLET	N/A
8	WINDOW DISPLAY (135K, 190K, 215K)	68-3009	23	CARBON ROTOR SEE ROTOR KIT	N/A	48	HANDLE (75K)	68-6114
9	THERMOSTAT CONTROL KNOB	68-3010	24	END PUMP COVER	68-3045	49	FRONT HANDLE (135K)	68-3092
10	LOWER SHELL (75K)	N/A	26	LINT FILTER SEE 68-3046	N/A	-	FRONT HANDLE (190K, 215K)	68-3093
-	LOWER SHELL (135K)	N/A	27	OUTPUT FILTER SEE 68-3046	N/A	50	REAR HANDLE (135K)	68-3094
-	LOWER SHELL (190K)	N/A	28	INLET FILTER SEE 68-3046	N/A	-	REAR HANDLE (190K, 215K)	68-3095
-	LOWER SHELL (215K)	N/A	29	END FILTER COVER	68-3047	51	WHEEL SUPPORT FRAME (135K)	68-3167
11	AIR LINE (75K)	68-3011	30	PLUG/PUMP ADJUSTMENT KIT	68-3048	-	WHEEL SUPPORT FRAME (190K, 215K)	68-3168
-	AIR LINE (135K)	68-3012	31	NIPPLE	68-3049	52	WHEEL AXLE (135K)	68-3246
-	AIR LINE (190K)	68-3013	32	CAPACITOR (75K)	68-3234	-	WHEEL AXLE (190K, 215K)	68-3247
-	AIR LINE (215K)	68-3014	-	CAPACITOR (135K, 190K, 215K)	68-3051	53	WHEEL - (135K, 190K, 215K)	68-3090
12	THERMOSTAT LIMIT CONTROL (75K, 135K, 190K)	68-3015	33	FAN ASSEMBLY (75K)	68-3052	54	WHEEL NUT (135K, 190K, 215K)	30-3031
-	THERMOSTAT LIMIT CONTROL (215K)	68-3016	-	FAN ASSEMBLY (135K)	68-3053	56	CORD WRAP (75K)	68-3075
13	COMBUSTION CHAMBER ASSEMBLY (75K)	68-3017	-	FAN ASSEMBLY (190K, 215K)	68-3054	-	CORD WRAP (135K, 190K, 215K)	68-3076
-	COMBUSTION CHAMBER ASSEMBLY (135K)	68-3018	34	IGNITOR (75K, 135K, 190K, 215K)	68-3056	57	MOTOR SUPPORTER (75K)	68-3243
-	COMBUSTION CHAMBER ASSEMBLY (190K, 215K)	68-3020	35	RIGHT SIDE COVER (75K)	68-3057	-	MOTOR SUPPORTER (135K, 190K, 215K)	68-3244
14	PHOTOCELL BRACKET	68-3021	-	RIGHT SIDE COVER (135K)	68-3058	58	ROOM TEMPERATURE SENSOR (75K, 135K, 190K, 215K)	68-3169
15	FUEL LINE (75K)	68-3022	-	RIGHT SIDE COVER (190K)	68-3059	59	PCB SUPPORT BRACKET (75K, 135K, 190K, 215K)	68-3170
-	FUEL LINE (135K)	68-3023	-	RIGHT SIDE COVER (215K)	68-3060		HARDWARE KIT (75K) (Inc. 53, 60, & SCREWS)	68-3078
-	FUEL LINE (190K)	68-3024	36	LEFT SIDE COVER (75K)	68-3061		HARDWARE KIT (135K, 190K, 215K)	68-3248
-	FUEL LINE (215K)	68-3025	-	LEFT SIDE COVER (135K)	68-3062		(Inc. 56, ALL SCREWS, NUTS, WASHERS,	-
16	PHOTOCELL ASSEMBLY	68-3026	-	LEFT SIDE COVER (190K, 215K)	68-3063		BUSHINGS, & COTTER PINS)	-
17	BURNER HEAD ASSEMBLY (75K)	68-3027	37	FAN GUARD (75K)	68-3064		FILTER KIT (Inc. 26-28)	68-3046
-	BURNER HEAD ASSEMBLY (135K)	68-3028	-	FAN GUARD (135K, 190K)	68-3065		ROTOR KIT (75K, 135K) (Inc. 23, BLADE & INSERT)	68-3043
-	BURNER HEAD ASSEMBLY (190K)	68-3029	-	FAN GUARD (215K)	68-3171		ROTOR KIT (190K, 215K) (Inc. 23, BLADE & INSERT)	68-3044
-	BURNER HEAD ASSEMBLY (215K)	68-3030	38	MAIN PCB ASSEMBLY (75K)	68-3066			
			-	MAIN PCB ASSEMBLY (135K, 190K, 215K)	68-3067			

Manufactured by Mi-T-M
50 Mi-T-M Drive, Peosta IA 52068
563-556-7484/ Fax 563-556-1235