



Performance Under Pressure

HAND CARRY GASOLINE
AIR COMPRESSOR
OPERATOR'S MANUAL



CAUTION

RISK OF INJURY! READ ENTIRE MANUAL
BEFORE OPERATING! THIS MANUAL IS AN IMPORTANT
PART OF THE AIR COMPRESSOR AND MUST REMAIN
WITH THIS UNIT WHEN YOU SELL OR RENT IT!

TABLE OF CONTENTS

INTRODUCTION	3
IMPORTANT	3
INSPECTION	3
SAFETY WARNINGS	4-7
RISK OF EXPLOSION OR FIRE.....	4
RISK OF BURSTING.....	5
RISK TO BREATHING.....	5
RISK OF BURNS.....	6
RISK OF FLYING OBJECTS	6
RISK FROM NEGLIGENCE	7
RISK OF AIR COMPRESSOR DAMAGE.....	7
FEATURES DRAWINGS	8
FEATURES REVIEW	9
PREPARATION	10
INITIAL SET-UP.....	10
LOCATION	10
GASOLINE ENGINE	10
PRE-START CHECKLIST	10
OPERATION	11
START-UP	11
SHUTDOWN	11
MAINTENANCE	11
TROUBLESHOOTING	12-13
WARRANTY	14
NOTES	15

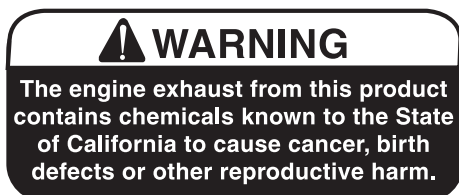

INTRODUCTION

Congratulations on the purchase of your new Mi-T-M® Air Compressor! You can be assured your Mi-T-M Air Compressor was constructed with the highest level of precision and accuracy. Each component has been rigorously tested by technicians to ensure the quality, endurance and performance of this air compressor.

This operator's manual was compiled for your benefit. By reading and following the simple safety, installation and operation, maintenance and troubleshooting steps described in this manual, you will receive years of trouble free operation from your new Mi-T-M Air Compressor. The contents of this manual are based on the latest product information available at the time of publication. Mi-T-M reserves the right to make changes in price, color, materials equipment, specifications or models at any time without notice.



IMPORTANT!

A "**DANGER, WARNING or CAUTION**" safety warning will be surrounded by a "**SAFETY ALERT BOX**". This box is used to designate and emphasize Safety Warnings that must be followed when operating this air compressor. Accompanying the safety warnings are "**Signal Words**" which designate the degree or level of hazard seriousness. The "**Signal Words**" used in this manual are as follows:

DANGER: Indicates an imminently hazardous situation which, if not avoided, **WILL** result in death or serious injury.

WARNING: Indicates a potentially hazardous situation which, if not avoided, **COULD** result in death or serious injury.

CAUTION: Indicates a potentially hazardous situation which, if not avoided **MAY** result in minor or moderate injury or damage to the air compressor.



The symbols set to the left of this paragraph are "**Safety Alert Symbols**". These symbols are used to call attention to items or procedures that could be dangerous to you or other persons using this equipment.

ALWAYS PROVIDE A COPY OF THIS MANUAL TO ANYONE USING THIS EQUIPMENT. READ ALL INSTRUCTIONS IN THIS MANUAL AND ANY INSTRUCTIONS SUPPLIED BY MANUFACTURERS OF SUPPORTING EQUIPMENT BEFORE OPERATING THIS AIR COMPRESSOR AND ESPECIALLY POINT OUT THE "SAFETY WARNINGS" TO PREVENT THE POSSIBILITY OF PERSONAL INJURY TO THE OPERATOR.

INSPECTION

Once the air compressor is removed from the box, write in the serial number in the space provided below. Inspect for signs of obvious or concealed freight damage. Be sure that all damaged parts are replaced and any mechanical problems are corrected prior to the operation of the air compressor.

SERIAL NUMBER _____

If you have questions, contact your Mi-T-M® Customer Service Representative at 1-800-553-9053

Please have the following information available for all service calls:

1. Model Number
2. Serial Number
3. Date and Place of Purchase



Mi-T-M® Corporation 8650 Enterprise Drive, Peosta, IA 52068



SAFETY WARNINGS

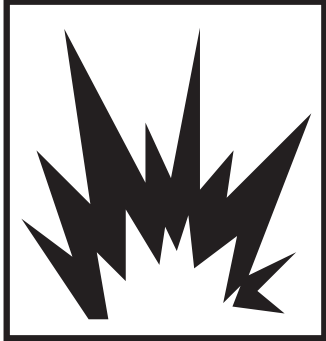

WARNING: WHEN USING THIS PRODUCT, BASIC PRECAUTIONS SHOULD ALWAYS BE OBSERVED, INCLUDING THE FOLLOWING. READ ALL SAFETY WARNINGS BEFORE USING AIR COMPRESSOR



HAZARD	POTENTIAL CONSEQUENCE	PREVENTION
<p data-bbox="217 281 493 342">RISK OF EXPLOSION OR FIRE</p>  	<p data-bbox="581 281 984 401">Serious injury or death may occur from normal sparks in the engine ignition system or engine exhaust/muffler.</p> <p data-bbox="581 646 941 707">Injury or death may occur as a result of improper fueling.</p> <p data-bbox="581 1745 984 1892">Serious injury may occur if any air compressor ventilation openings are restricted, causing the air compressor to overheat and start a fire.</p>	<p data-bbox="1019 281 1409 432">Always operate air compressor in a well ventilated area free of flammable vapors, combustible dust, gases or other combustible materials.</p> <p data-bbox="1019 468 1433 585">DO NOT SMOKE if spraying flammable material. Locate the air compressor at least 20 feet away from the spray area.</p> <p data-bbox="1019 646 1409 707">Do not smoke while filling engine fuel tank.</p> <p data-bbox="1019 743 1409 861">Never fill the engine fuel tank while the engine is running or hot. Allow the engine to cool two minutes before refueling.</p> <p data-bbox="1019 896 1433 957">Do not refuel indoors or in a poorly ventilated area.</p> <p data-bbox="1019 993 1409 1075">Always refuel slowly to avoid the possibility of spilled fuel which may cause a risk of fire.</p> <p data-bbox="1019 1110 1425 1257">Do not operate the unit if gasoline is spilled. Wipe the air compressor clean and move it away from the spill. Avoid starting until the gasoline has evaporated.</p> <p data-bbox="1019 1293 1409 1470">Do not store the air compressor near an open flame or any equipment such as a stove, furnace, water heater, etc. which utilizes a pilot light or sparking device.</p> <p data-bbox="1019 1505 1417 1715">A spark arrester must be added to the muffler of this engine if it is to be used on any forest covered, brush covered or grass covered unimproved land. The arrester must be maintained in effective working order by the operator.</p> <p data-bbox="1019 1751 1417 1927">Never place objects against or on top of air compressor. Operate air compressor at least 12 inches away from any wall or obstruction that would restrict proper ventilation.</p>



SAFETY WARNINGS

READ ALL SAFETY WARNINGS BEFORE USING AIR COMPRESSOR

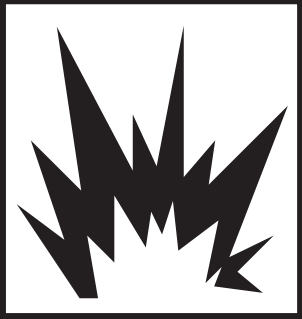



HAZARD	POTENTIAL CONSEQUENCE	PREVENTION
<p>RISK OF BURSTING</p> 	<p>Serious injury or death may occur from an air tank explosion if air tanks are not properly maintained.</p> <p>Serious injury may occur from an air compressor malfunction or exploding accessories if incorrect system components, attachments or accessories are used.</p>	<p>Drain air tank daily or after each use to prevent moisture buildup in the air tank.</p> <p>If air tank develops a leak, replace the air tank immediately. Never repair, weld or make modifications to the air tank or its attachments. Use only genuine Mi-T-M® repair parts for your air compressor.</p> <p>Never make adjustments to the factory set pressures.</p> <p>Never exceed manufacturers maximum allowable pressure rating of attachments.</p> <p>Use caution when inflating small, low pressure objects such as toys.</p>
<p>RISK TO BREATHING</p> 	<p>Serious injury or death could occur from inhaling compressed air. The air stream may contain carbon monoxide, toxic vapors or solid particles.</p> <p>Serious injury or death may occur from inhaling engine exhaust.</p> <p>Sprayed materials such as paint, paint solvents, paint remover, insecticides, weed killers, etc. contain harmful vapors and poisons.</p>	<p>Never inhale air from the air compressor either directly or from a breathing device connected to the air compressor.</p> <p>This air compressor was designed for outdoor use. Never operate this air compressor in an enclosed area. Always make certain there is adequate ventilation (fresh outside air) for breathing and combustion. This will prevent the buildup of dangerous carbon monoxide gases. Beware of poorly ventilated areas, or areas with inadequate exhaust fans.</p> <p>Operate air compressor only in a well ventilated area. Follow all safety instructions provided with the materials you are spraying. Use of a respirator may be required when working with some materials.</p>



SAFETY WARNINGS

READ ALL SAFETY WARNINGS BEFORE USING AIR COMPRESSOR



HAZARD	POTENTIAL CONSEQUENCE	PREVENTION
<p>RISK OF BURNS</p> 	<p>Serious injury could occur from touching exposed metal parts. These areas can remain hot for some time after the air compressor is shutdown.</p>	<p>Never allow any part of your body or other materials to make contact with any exposed metal parts on the air compressor.</p> <p>Never allow any part of your body to contact the engine muffler or adjacent areas.</p>
<p>RISK OF FLYING OBJECTS</p> 	<p>Soft tissue damage can occur from the compressed air stream.</p> <p>Serious injury can occur from loose debris being propelled at a high speed from the compressed air stream.</p>	<p>Always wear safety glasses to shield the eyes from flying debris.</p> <p>Never point the air stream at any part of your body, anyone else or animals.</p> <p>Never leave pressurized air in the air compressor. Shut off air compressor and relieve pressure when storing or before maintenance.</p> <p>Always maintain a safe distance from people and animals while operating the air compressor.</p> <p>Do not move the air compressor while air tank is under pressure. Do not attempt to move the air compressor by pulling on the hose.</p>



SAFETY WARNINGS

READ ALL SAFETY WARNINGS BEFORE USING AIR COMPRESSOR



HAZARD	POTENTIAL CONSEQUENCE	PREVENTION
RISK FROM NEGLIGENCE	Risk of injury from negligent use.	<p>Never allow children or adolescents to operate this air compressor!</p> <p>Stay alert-watch what you are doing. Do not operate the air compressor when fatigued or under the influence of alcohol or drugs.</p> <p>Know how to stop the air compressor. Be thoroughly familiar with controls.</p>
RISK OF AIR COMPRESSOR DAMAGE	Risk of major repair.	<p>Do not operate air compressor without an air filter.</p> <p>Do not operate air compressor in a corrosive environment.</p> <p>Always operate the air compressor in a stable, secure position to prevent air compressor from falling.</p> <p>Follow all maintenance instructions listed in this manual.</p>

! SAVE THESE INSTRUCTIONS !

MI-T-M GASOLINE HAND CARRY AIR COMPRESSOR FEATURES

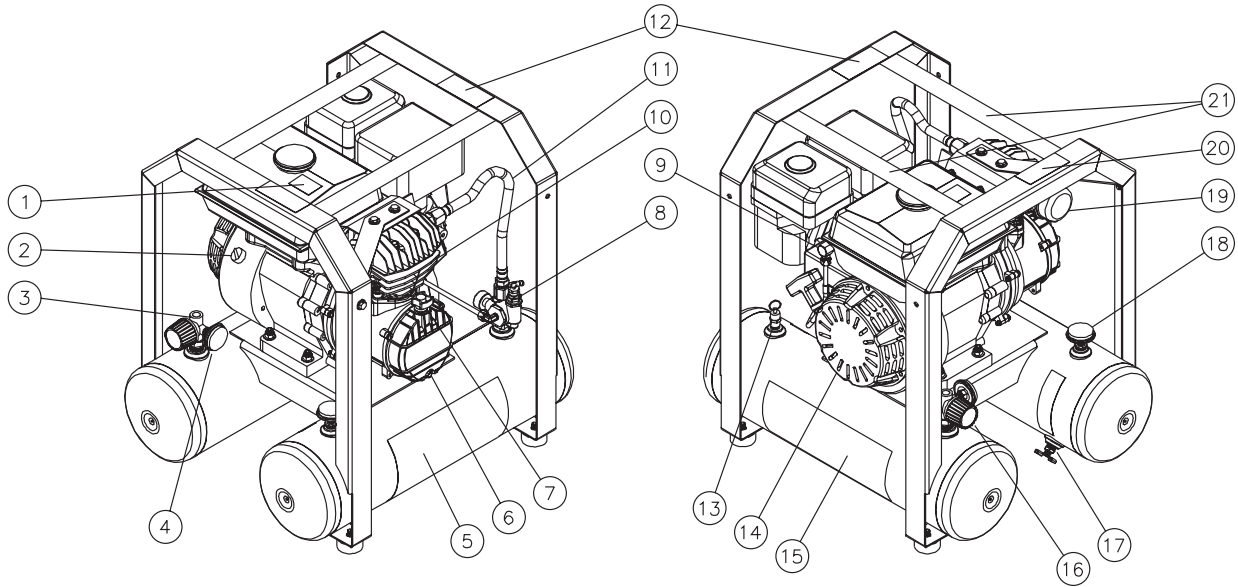

AC1-HH04-05M-031102-DLG

1. Decal- Caution: Risk of Fire
2. Engine On/Off Switch
3. Outlet
4. Outlet Pressure Gauge
5. Decal- Danger/Warning/Caution
6. Pump Oil Drain
7. Pump Oil Fill Port/Vent/Dipstick
8. Pilot Valve
9. Engine Throttle Control
10. Pump
11. Pump Discharge Hose
12. Decal- Warning: Muffler Hot/Hot Surfaces
13. Pressure Relief Valve
14. Engine
15. Decal- Mi-T-M Logo
16. Pressure Regulator
17. Tank Drain
18. Tank Pressure Gauge
19. Air Intake Filter
20. Decal- Warning: Hot Surfaces
21. Lift Handles

EXPLODED VIEW & EXPLANATION OF AIR COMPRESSOR FEATURES

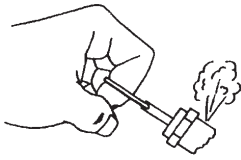

SAFETY RELIEF VALVE: This valve is designed to prevent system failures by relieving pressure from the system when the compressed air reaches a predetermined level. The valve is preset by the manufacturer and must not be modified in any way. To verify the valve is working properly, pull on the ring. Air pressure should escape. When the ring is released, it will reseal.

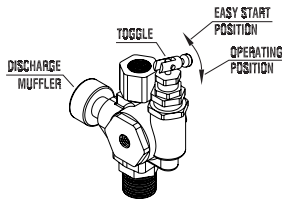

PILOT VALVE: When the toggle is in the upright position, all air from the air compressor is vented through the discharge muffler. This gives an easy start feature. For normal operation, the toggle is in the 90° position.

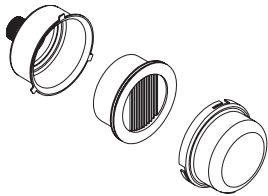

AIR INTAKE FILTER: This filter is designed to clean air coming into the pump. To ensure the pump continually receives a clean, cool, dry air supply this filter must always be clean and ventilation opening free from obstructions. Replace filter element when necessary.

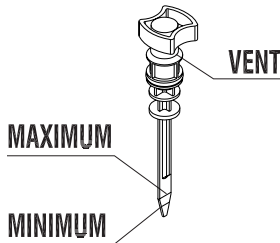

OIL DIPSTICK: The dipstick will register the amount of oil in the pump. Oil level should be checked on a daily basis to ensure it does not exceed the maximum notch or fall below the minimum notch on the dipstick. If low, add SAE 30W non-detergent oil.

OIL FILL PORT/VENT: Pour oil into the Oil Fill Port/Vent when required.

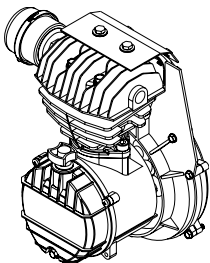

AIR COMPRESSOR PUMP: To compress air, the piston moves up and down in the cylinder. On the down stroke, air is drawn in through the air intake valves while the exhaust valves remain closed. On the up stroke, air is compressed, the intake valves close and compressed air is forced out through the exhaust valves, into the discharge line, through the pilot valve and into the air tank.

AIR TANK PRESSURE GAUGE: The air tank pressure gauge indicates the reserve air pressure in the air tank (s).

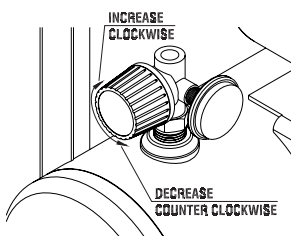

PRESSURE REGULATOR: The air pressure coming from the air tank is controlled by the regulator knob. Turn the pressure regulation knob clockwise to increase discharge pressure, and counterclockwise to decrease discharge pressure.

OUTLET PRESSURE GAUGE: The outlet pressure gauge indicates the air pressure available at the outlet side of the regulator. This pressure is controlled by the regulator and is always less or equal to the air tank pressure.

AIR TANK DRAIN VALVE: The drain valve is used to remove moisture from the air tank(s) after the air compressor is shut off. **NEVER attempt to open the drain valve when more than 10 PSI of air pressure is in the air tank!** To open the drain valve, turn the knob counterclockwise.

PREPARATION

INITIAL SET-UP:

1. Read safety warnings before setting-up air compressor.
2. This unit is shipped without oil in the engine and compressor crankcases.
Compressor Pump: Remove oil dipstick and fill with approximately 4 ounces of SAE 30W non-detergent oil. The oil level should not exceed the top raised line on the dipstick.
Engine: Remove oil cap (follow engine manufacturer's specifications in engine manual) and fill the crankcase to the proper level. Always use quality 4-stroke automotive detergent oil.

LOCATION:

1. In order to avoid damaging the air compressor, do not operate the air compressor when it is inclined in any direction more than 10°.
2. Place air compressor at least 12 inches away from obstacles that may prevent proper ventilation. Do not place air compressor in an area:
 - where there is evidence of oil or gas leaks.
 - where flammable gas vapors or materials may be present.
 - where extremely dirty air or water could be drawn into the air compressor.

GASOLINE ENGINE:

1. Review "Risk of Fire or Explosion" pg. 4 before fueling.
2. Read the engine manual accompanying this air compressor for correct engine start-up maintenance procedures.
3. Read and understand the safety labels located on the air compressor.
4. A minimum of 85 octane fuel is recommended for use with this air compressor. Do not mix oil with gasoline.
5. Use of clean, fresh, lead free gasoline is recommended. Leaded gasoline may be used if lead free is not available. Do not use gasoline containing methanol or alcohol.
6. Fill the fuel tank according to the engine manual instruction.
7. Refer to the engine manual for all necessary maintenance and adjustments.

PRE-START CHECKLIST:

1. Check oil levels. Add oil if necessary.
2. Remove any moisture in the air compressor air tank. **NEVER attempt to open the Air Tank Drain Valve when more than 10 PSI of air pressure is in the air tank!** Remove excessive pressure with an air tool, then open the Air Tank Drain Valve in the bottom of the air tank. Close tightly when drained.
3. Make sure the Engine Switch is in the "OFF" position.
4. Make sure the Pressure Relief Valve is working correctly.



WARNING

RISK OF EXPLOSION OR FIRE
CAUSING SERIOUS INJURY OR
DEATH!

Do not allow the engine or muffler to come in contact with flammable vapors, combustible dust, gases or other combustible materials. A spark may cause a fire.

When using the air compressor for spray painting, place the air compressor as far away from the work area as possible, using extra air hoses if needed.



DANGER

RISK OF EXPLOSION OR FIRE
CAUSING SERIOUS INJURY
OR DEATH! Do not smoke while fueling!

Do not fill fuel tank while air compressor is running or hot. Allow air compressor and engine to cool down for two minutes before refueling. Do not fill fuel tank to point of overflowing. Allow approximately 1/4" of tank space for fuel expansion.



WARNING

RISK OF EXPLOSION OR FIRE
CAUSING SERIOUS INJURY
OR DEATH! Do not place unit in an area where flammable gas vapors may be present. A spark could cause an explosion or fire.

Always store fuel away from the air compressor while it is running or hot.



WARNING

RISK OF ASPHYXIATION!
Do not operate in an enclosed area. Use this product only in well ventilated areas! The exhaust from the engine contains carbon monoxide, a poisonous, odorless and invisible gas. Breathing the gas can cause serious injury, illness and possible death.



WARNING

RISK OF BODILY INJURY!
Never attempt to open the Air Tank Drain Valve when more than 10 PSI of air pressure is in the air tank!

OPERATION

START-UP:

1. Read safety warnings before performing operation.
2. Flip the toggle on top of the Pilot Valve to the upright position. This provides a loadless start. The air compressor will unload and allow easier engine start-up.
3. Start the engine. (Refer to the Engine Manual accompanying this unit.) This unit is manufactured with an automatic throttle idle control device which reduces engine speed when the compressor is unloaded and returns the engine to full speed when the compressor is loaded. The engine's throttle control is automatic and the control lever does not need to be moved on this unit.
4. When the engine has run for 1-2 minutes, flip toggle back to the original position.
5. Set pressure by adjusting the Pressure Regulator counterclockwise for less pressure and clockwise for more pressure.
6. If you notice any unusual noise or vibration, stop the air compressor and refer to "Troubleshooting".

SHUTDOWN:

1. To stop the air compressor, move the Engine Switch to the "Off" position. (Refer to the Engine Manual accompanying this unit.)
2. Drain air from the air tanks by releasing air with an attached air tool or by pulling on the Pressure Relief Valve.
3. Once the Air Tank Pressure Gauge registers under 10 pounds, open the drain valve under each air tank to drain any moisture.
4. Allow the air compressor to cool down.
5. Wipe air compressor clean and store in a safe, non-freezing area.

MAINTENANCE

Read the instruction manual before performing maintenance. The following procedures must be performed when stopping the air compressor for maintenance or service.

1. Turn off air compressor.
2. Disconnect spark plug wire from engine.
3. Open all drains.
4. Wait for the air compressor to cool before starting service.

MAINTENANCE CHART

PROCEDURE	DAILY	WEEKLY	MONTHLY	200 HOURS
Check pump oil level	X			
Check engine oil level	X			
Oil leak inspection	X			
Check engine air filter	X			
Drain condensation in air tank(s)	X			
Check for unusual noise/vibration	X			
Check for air leaks	X			
Clean exterior of compressor		X		
Inspect air filter		X		
Check safety relief valve			X	
Change pump oil *				X
Replace air filter				X
Check engine spark plug				X

*The pump oil must be changed after the first 50 hours of operation and every 200 hours or 3 months, whichever comes first.

The engine oil must be changed after the first 8 hours of operation and every 50 hours or 3 months, whichever comes first.

Every 2 years, an Authorized Service Technician should check the check valve, intake valves and delivery valves.

TROUBLESHOOTING

SYMPTOM	PROBABLE CAUSE	REMEDY
Engine will not start.	Various engine problems.	Refer to the engine manual accompanying your air compressor.
Engine lacks power.	Filter element plugged.	Clean or replace filter element.
	Bad Fuel.	Drain fuel; refuel with fresh gasoline.
	Various engine problems.	Refer to the engine manual accompanying your air compressor.
Noisy operation.	Lack of oil in the pump.	Add correct amount of oil. Check for bearing damage.
	Carbon deposits on pistons or valves.	Remove cylinder head and inspect. Clean or replace.
	Bearing, piston or connecting rod failure.	STOP THE AIR COMPRESSOR! Contact Mi-T-M Customer Service.
Pressure drop in air tank or rapid pressure loss when air compressor is shut off.	Air leaks at connections.	Allow air compressor to build pressure to the maximum allowed. Turn off and brush a soapy water solution onto all connections. Check connections for air bubbles. Tighten the connections where leaks are present.
	Air leak in air tank.	Air tank must be replaced. Do not attempt to repair air tank!
	Defective Pilot Valve.	Clean or replace.
Insufficient pressure at air tool or accessory.	Pressure Regulator not turned to high enough pressure or defective.	Adjust Pressure Regulator to proper setting or replace.
	Restricted air intake .	Clean or replace Air Intake Filter.
	Air leaks or restrictions.	Check for leaks and repair.
	Hose or hose connections are too small or long.	Replace with larger hose or connectors.
	Slipping belt.	Tighten or replace.
	Air compressor is not large enough for air requirement.	Check the accessory air requirement. If it is higher than the CFM or pressure supply to the air compressor, use a larger air compressor.
	Restriction in Pilot Valve.	Clean or replace.

TROUBLESHOOTING

SYMPTOM	PROBABLE CAUSE	REMEDY
Air leaks from Pressure Relief Valve	Possible defective Pressure Relief Valve.	Operate Pressure Relief Valve manually by pulling on ring. If it still leaks, it should be replaced.
	Excessive air tank pressure.	Clean, reset or replace Pilot Valve.
Air leaks at pump.	Defective gaskets.	Torque head bolts: Single Stage = 15 ft./lbs.
Air blowing from Air Intake Filter.	Defective inlet (reed) valve.	Contact Mi-T-M Customer Service.
Moisture in discharge air.	Condensation in air tank caused by high level of atmospheric humidity or air compressor is not run long enough.	Run air compressor a minimum of one hour to prevent condensation buildup. Drain air tank after every use. Drain air tank more often in humid weather and use an air line filter.
Excessive oil consumption or oil in hose.	Restricted Air Intake Filter.	Clean or replace.
	Air compressor on un-level surface.	Do not incline the air compressor more than 10° in any direction while running.
	Crankcase overfilled with oil.	Drain oil. Refill to proper level with SAE-30W non-detergent oil.
	Wrong viscosity.	Drain oil. Refill to proper level with SAE-30W non-detergent oil.
	Plugged oil dipstick vent.	Clean.
	Worn piston rings or scored cylinder.	Contact Mi-T-M Customer Service.
Oil has milky appearance.	Water in oil due to condensation.	Change oil and move air compressor to a less humid environment.

MI-T-M PORTABLE GASOLINE AIR COMPRESSOR STATEMENT OF WARRANTY

Mi-T-M Corporation warrants all parts, (except those referred to below), of your new air compressor to be free from defects in materials and workmanship during the following periods:

For One (1) years from the date of original purchase:
Compressor Pump Plumbing
Tank Assembly

For Six (6) months from date of original purchase:
Pressure Switch Regulator
Check Valve Copper Line

For Ninety (90) days from the date of original purchase:
Pressure Gauges Safety Relief Valves
Drain Valves

Defective parts not subject to normal wear and tear will be repaired or replaced at our option during the warranty period. In any event, reimbursement is limited to the purchase price paid.

EXCLUSIONS

1. Engine is covered under separate warranty by its respective manufacturer and is subject to the terms set forth therein.
2. Normal wear parts:
Isolators Air Filter
3. This warranty does not cover parts damaged due to normal wear, abnormal conditions, misapplication, misuse, accidents, operation at other than recommended speeds, pressures or temperature, improper storage or freight damage. Parts damaged or worn by operation in dusty environments are not warranted. Failure to follow recommended operating and maintenance procedures also voids warranty.
4. Labor charges, loss or damage resulting from improper operation, maintenance (other than routine air tank draining and oil changes, if applicable) or repairs made by persons other than a Mi-T-M Authorized Service Center.
5. The use of other than Genuine Repair Parts will void warranty. Parts returned, prepaid to our factory or to an Authorized Service Center will be inspected and replaced free of charge if found to be defective and subject to warranty. Under no circumstances shall the manufacturer bear any responsibility for loss of use of the unit, loss of time or rental, inconvenience, commercial loss or consequential damages. There are no warranties which extend beyond the description of the face hereof.

For Service or Warranty consideration, contact:
Mi-T-M Corporation, 8650 Enterprise Drive, Peosta, IA 52068-0050
563-556-7484 / 800-553-9053 / Fax 563-556-1235

Monday-Friday 8:00 a.m. - 5:00 p.m. CST