



**8650 Enterprise Drive, Peosta, IA 52068-0050
319-556-7484 / Fax 319-556-1235**

**OPERATORS MANUAL FOR Mi-T-M®
BIO-RS25
BIOLOGICAL RECYCLING
SYSTEM**

**CAUTION
RISK OF INJURY!
READ MANUAL BEFORE OPERATING!**
**This manual is an important part of the Biological Recycling System and
must remain with the unit when you sell it!**

Contents

INTRODUCTION	3
CONTENTS OF BIOLOGICAL RECYCLING SYSTEM	4
SPECIFICATIONS	4
PURPOSE	4
IMPORTANT SAFETY WARNINGS	5-7
RISK OF ELECTRIC SHOCK OR ELECTROCUTION	5
RISK OF EXPLOSION OR FIRE	6
RISK OF BURSTING	6
RISK OF BURNS	6
RISK FROM MOVING PARTS	7
RISK OF BODILY INJURY	7
FLOW CHART	8
INSTALLATION	9-12
ATTIRE	9
INSTALLATION	9-11
PRESTART CHECKLIST	12
PREPARATION	13
PRESTART PROCEDURES	13
START-UP	13
OPERATION	14
BEGIN	14
MAINTENANCE	14
ROUTINE MAINTENANCE	14
WINTERIZING	14
TROUBLESHOOTING	15-17
STATEMENT OF WARRANTY	19

INTRODUCTION

Congratulations on the purchase of your new Mi-T-M Biological Recycling System! You can be assured your Mi-T-M Biological Recycling System was constructed and designed with quality and performance in mind. Each component has been rigorously tested to ensure the highest level of acceptance.

This operator's manual was compiled for your benefit. By reading and following the simple safety, installation, operation, maintenance and troubleshooting steps described in this manual, you will receive years of trouble free operation from your new Mi-T-M Biological Recycling System. The contents of this manual are based on the latest product information available at the time of publication. Mi-T-M reserves the right to make changes in price, color, materials, equipment, specifications or models at any time without notice.

! IMPORTANT !

These paragraphs are surrounded by a "SAFETY ALERT BOX". This box is used to designate and emphasize Safety Warnings that must be followed when operating this Biological Recycling System.

Accompanying the Safety Warnings are "signal words" which designate the degree or level of hazard seriousness. The "signal words" used in this manual are as follows:

DANGER: Indicates an imminently hazardous situation which, if not avoided, WILL result in death or serious injury.

WARNING: Indicates a potentially hazardous situation which, if not avoided, COULD result in death or serious injury.

CAUTION: Indicates a potentially hazardous situation which, if not avoided MAY result in minor or moderate injury.



The symbols set to the left of this paragraph are "Safety Alert Symbols". These symbols are used to call attention to items or procedures that could be dangerous to you or other persons using this equipment.

ALWAYS PROVIDE A COPY OF THIS MANUAL TO ANYONE USING THIS EQUIPMENT. READ ALL INSTRUCTIONS BEFORE OPERATING THIS BIOLOGICAL RECYCLING SYSTEM AND ESPECIALLY POINT OUT THE "SAFETY WARNINGS" TO PREVENT THE POSSIBILITY OF PERSONAL INJURY TO THE OPERATOR.

Once the unit has been uncrated, immediately write in the serial number of your unit in the space provided below.

SERIAL NUMBER _____

Inspect for signs of obvious or concealed freight damage. If damage does exist, file a claim with the transportation company immediately. Be sure that all damaged parts are replaced and that the mechanical and electrical problems are corrected prior to operation of the unit. If you require service, contact Mi-T-M Customer Service.

CUSTOMER SERVICE
CALL OUR TOLL-FREE NUMBER
for the Sales or Service Center nearest you!
800-553-9053

Please have the following information available for all service calls:

1. Model Number
2. Serial Number
3. Date and Place of Purchase

CONTENTS OF THE BIOLOGICAL RECYCLING SYSTEM

Carefully unpack your new Mi-T-M Biological Recycling System. Check the contents against the packing list. Contact the freight line if a damage claim is required on any component. The following items are the basic equipment sent with your Biological Recycling System.

1. Biological Recycling System Platform
 - a. Filter Pump
 - b. Pressurized Water Storage Tank
 - c. Cartridge Filter
2. Manual

SPECIFICATIONS

MODEL	BIO-RS25
MAXIMUM FLOW	25 GPM
ELECTRICAL	230 V, 1 Phase, 20 Amp
FILTER PUMP (CENTRIFUGAL)	1 HP
CARTRIDGE FILTER	5 Micron
DIMENSIONS L x W x H	12' x 6' x 4'
NET WEIGHT	1,400 pounds

PURPOSE

The Mi-T-M Biological System was designed to offer a solution to waste disposal that is economical, efficient and foremost, *environmentally safe*. As we move into the 21st century, environmental waste codes are becoming more and more strict. Surcharges and fines are being mandated to companies that are unable to operate within acceptable guidelines. Chemicals used to treat waste water often create by-products which in themselves cause additional code violations. Mi-T-M Corporation has solved this problem by engineering a Bio-System that utilizes *microbes*, not chemicals, to literally feed off of the waste in the water allowing the final output to be cleansed of any hazardous by-products. We at Mi-T-M realize the need to protect and respect our environment and therefore, our Bio-Systems operate under specific microbe guidelines, utilizing microbes that (1) is natural, not genetically formulated and (2) will not cause disease.

Mi-T-M has been involved in water products for over twenty-eight years. Our commitment to quality is passed on to our customers, our commitment to the environment is passed on to our children.



IMPORTANT SAFETY WARNINGS



WARNING: When using this product, basic precautions should always be observed, including the following:
READ ALL SAFETY WARNINGS BEFORE USING BIOLOGICAL RECYCLING SYSTEM



HAZARD	POTENTIAL CONSEQUENCE	PREVENTION
<p data-bbox="185 268 526 327">RISK OF ELECTRIC SHOCK OR ELECTROCUTION</p> 	<p data-bbox="561 268 974 489">Serious injury or death could occur if the Biological Recycling System is not properly grounded. Your Biological Recycling System is powered by electricity and may cause electric shock or electrocution if not installed properly.</p> <p data-bbox="561 1087 974 1171">Electrical shock may occur if Biological Recycling System is not operated properly.</p> <p data-bbox="561 1325 974 1409">Serious injury or death may occur if electrical repairs are attempted by unqualified persons.</p>	<p data-bbox="1016 268 1549 352">Installation of this unit, including all electrical connections, must comply with all local, state and national codes.</p> <p data-bbox="1016 373 1549 541">This product must be grounded. Connect to a GFCI circuit breaker when available. If the unit should malfunction or breakdown, grounding provides a path of least resistance for electric current to reduce the risk of electric shock. Do not ground to a gas supply line.</p> <p data-bbox="1016 562 1549 709">Improper connection of the equipment-grounding conductor can result in a risk of electrocution. Check with a qualified electrician or service personnel if you are in doubt as to whether the system is properly grounded.</p> <p data-bbox="1016 730 1549 867">Always be certain the unit is receiving proper voltage (+/- 5% of the voltage listed on the nameplate). Before installing electrical connections, be certain the power switches are in the "OFF" position.</p> <p data-bbox="1016 888 1549 909">Keep all connections dry and off the ground.</p> <p data-bbox="1016 930 1549 1066">Do not touch pump, pump motor, discharge piping or water when the unit is connected to the power supply; regardless of whether the unit is operating correctly or experiencing an operation failure.</p> <p data-bbox="1016 1087 1549 1171">DO NOT allow metal components of the Biological Recycling System to come in contact with live electrical components.</p> <p data-bbox="1016 1192 1549 1308">Never operate the Biological Recycling System with safety guards/covers removed or damaged. Ensure all electrical covers are securely in place when unit is operating.</p> <p data-bbox="1016 1329 1549 1434">Any electrical wiring or repairs performed on this Biological Recycling System should be done by Authorized Service Personnel in accordance with National and Local electrical codes.</p> <p data-bbox="1016 1455 1549 1801">Before opening any electrical enclosure, always shut off the Biological Recycling System and drain the water. Disconnect the Biological Recycling System from the power source. If the power disconnect is not in sight, lock it in the open position and tag it to prevent power usage. (Never assume the Biological Recycling System is safe to work on just because it is not operating, it could restart at any time! Always disconnect from the power source.) Allow the Biological Recycling System to cool down. Service in a clean, dry, flat area.</p>



IMPORTANT SAFETY WARNINGS

READ ALL SAFETY WARNINGS BEFORE USING BIOLOGICAL RECYCLING SYSTEM

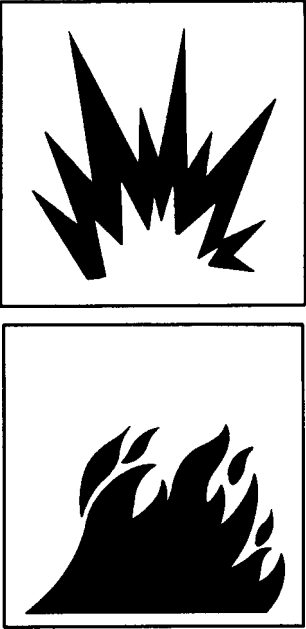
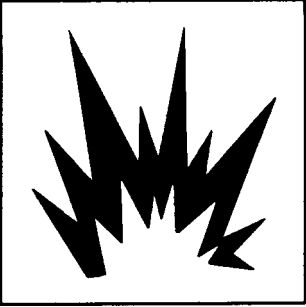



HAZARD	POTENTIAL CONSEQUENCE	PREVENTION
<p>RISK OF EXPLOSION OR FIRE</p> 	<p>Serious injury or death could occur from an explosion or fire caused by a system electric spark.</p>	<p>This unit must be placed in an area that is well ventilated, free of flammable vapors, combustible dust, gases or other combustible materials.</p>
<p>RISK OF BURSTING</p> 	<p>Serious injury or death could occur from bursting caused by excessive pressure in the system.</p> <p>Serious injury may occur if attempting to start the Biological Recycling System when the pump is frozen.</p>	<p>Do not mistreat the pressure gauges on the system. Pressure gauges will malfunction if they are subjected to excessive pressure, vibration, pulsation or temperature or if they are placed in an environment which causes corrosion of parts. Incorrect readings on a pressure gauge could mislead the operator and place him in a dangerous working condition.</p> <p>Do not use a booster pump or any type of additional pumping system. Pressurizing the suction of the pump may cause the pump body to explode.</p> <p>Do not use this Biological Recycling System to pump flammable material! An explosion could occur from a gas vapor buildup inside the system.</p> <p>In freezing temperatures, the unit must always be warm enough to ensure there is no ice formation in the pump. Do not start the Biological Recycling System if it has been in a freezing environment without first allowing the pump to thaw.</p>
<p>RISK OF BURNS</p> 	<p>Serious injury may occur from touching the electrical motor. This area can remain hot for some time after the Biological Recycling System is shutdown.</p>	<p>Never allow any part of your body to contact the electrical motor until cooled.</p>



IMPORTANT SAFETY WARNINGS

READ ALL SAFETY WARNINGS BEFORE USING BIOLOGICAL RECYCLING SYSTEM

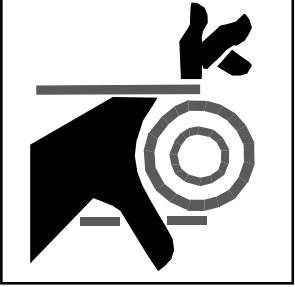

HAZARD	POTENTIAL CONSEQUENCE	PREVENTION
<p>RISK FROM MOVING PARTS</p> 	<p>Serious injury may occur to the operator from moving parts on the Biological Recycling System.</p>	<p>Do not operate the unit without all protective covers in place.</p> <p>Follow the maintenance instructions specified in the manual.</p>
<p>RISK OF BODILY INJURY</p> 	<p>Injury may occur from the Biological Recycling System.</p>	<p>DO NOT DRINK THE WATER IN THE BIOLOGICAL RECYCLING SYSTEM!! This is non-potable water and is not suitable for consumption.</p> <p>The Cartridge Filter operates under pressure. DO NOT attempt to loosen the locking ring or open the filter tank unless the pump is turned off and the air relief valve is opened.</p> <p>DO NOT allow children to operate this unit.</p> <p>DO NOT overreach or stand on unstable support.</p> <p>Wet surfaces can be slippery, wear protective foot gear and keep good footing and balance at all times.</p> <p>Know how to stop the Biological Recycling System. Be thoroughly familiar with controls.</p> <p>Before servicing, ALWAYS shut off the Biological Recycling System.</p>

! SAVE THESE INSTRUCTIONS! !

BIOLOGICAL RECYCLING SYSTEM FLOW CHART

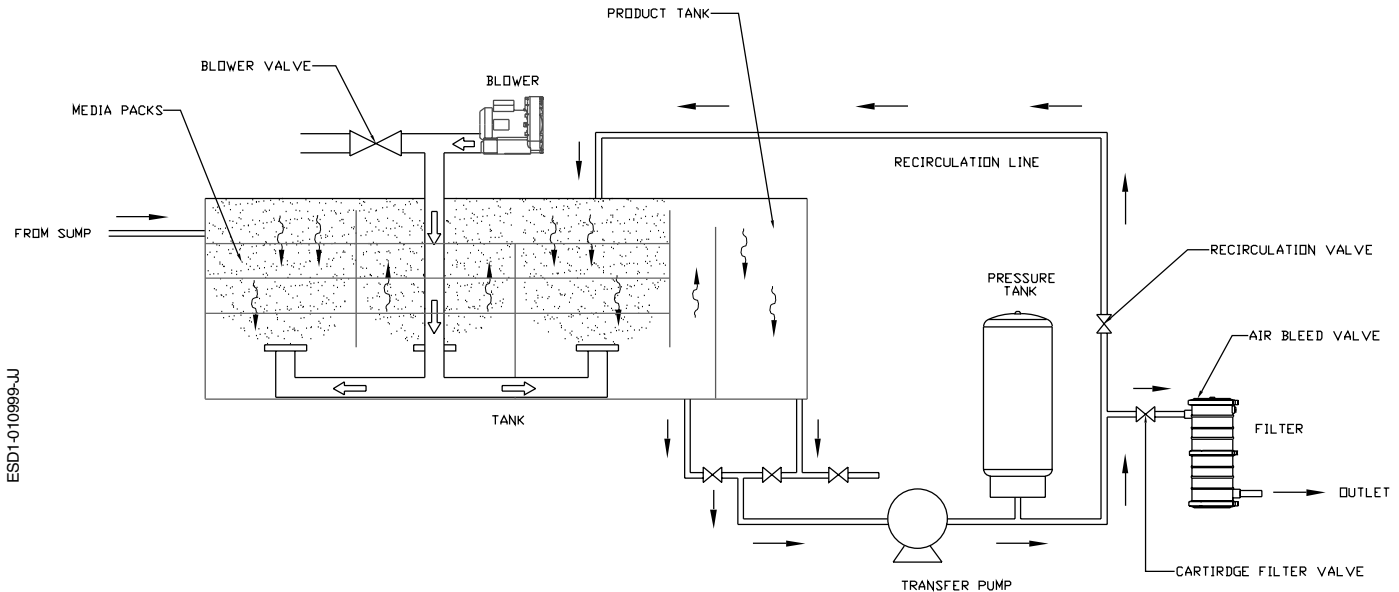

ESD1-010999-JJ

BIOLOGICAL RECYCLING SYSTEM FLOW CHART

The **Sump Pump** draws water from the **Sump Pit** and brings it to the Biological Recycling System. The **Biological System** is made up of several sections which are separated by weirs. The waste water enters the top of the **First Chamber** and moves down through the vertical coalescing media pack. The media pack collects and holds the organisms from the waste water. The microbes breakdown the molecular structure of the waste organisms, producing byproducts of carbon dioxide, water and the life sustaining bacteria that the microbes thrive on.

From there, the waste water moves under the weir, into the **Second Chamber**, rising up through the second media pack and over the weir into the Third Chamber. The waste water then flows down through this final media pack for a final cleansing before moving into the Water Level Control Tank. This very small section has a weir positioned to control the level of water in the **Bio-System**. The top of this weir is as high as the water level in the **Bio-System** can get. The water moves over this final weir and into the **Final Product Tank**. From there the water moves out through the **Final Product Tank Outlet**. This drain is positioned at the bottom of the **Final Product Tank** allowing the water to flow to the **Transfer Pump** when needed. When needed, water is pulled from the **Final Product Tank** by the **Transfer Pump** and moved into the **Pressure Tank**. This tank holds water at 20-40 PSI/1.4 - 2.8 Bar. From there, the water flows into the top of the **Cartridge Filter**. A **Cartridge Filter Drain Valve** is located at the bottom of the **Cartridge Filter** for filter cleaning purposes. This valve should be closed during the water treatment operation. On initial start-up, the **Air Bleed Valve** must be opened to let air escape while the **Cartridge Filter** fills with water. Once full, and the **Air Bleed Valve** is closed, the water passes through the Polyester Fiber filter which reduces the contaminants down to 20 microns. The water moves out of the **Cartridge Filter** to the water discharge outlets upon demand.

If water is needed for washing, water is sent to the **Outlet** and then to a pressure washer or garden hose.

INSTALLATION

ATTIRE:

1. Proper attire is essential to your safety. It is advised to utilize whatever means necessary to protect eyes, ears, and skin.

INSTALLATION:

1. A Collection Pit System must already be an established structure before installing the Biological Recycling System. A well designed pit system is critical for the proper operation of the recycle system. Consult your Mi-T-M dealer for installation requirements.
2. Place the Biological Recycling System platform on a hard, level surface in an area free of flammable vapors, combustible dust, gases or other combustible materials. Place a level on the **Biological System** to ensure it is level. Shim the **Skid** if necessary.
3. Set the unit so you have access to the filters and **Control Panel**.
4. Do not place unit in an area:
 - a. with insufficient ventilation.
 - b. where environmental hazards (i.e. rain and snow) can come in contact with the Biological Recycling System.
 - c. in a freezing environment.
5. The Biological Recycling System is shipped with union connections loosened to protect the unit from shipping damage. Tighten all union connections at this time.
6. Install schedule 80 PVC connections to the water inlet and return of the Bio-System.
7. Install the **Sump Pump** in the **Sump Pit** as shown below.
8. Install plumbing from the **Sump Pump** using 1 1/2" minimum connection sizes.
9. Install a check valve near the outlet plumbing of the **Sump Pit**.
10. Install the return plumbing using 2" minimum connection sizes.
11. Install the two floats in the **Sump Pit**. Allow a 2" tether and enough room for them to move freely without interfering with the plumbing.
 - a. Float #1 Blue: Pit low level shut-off. Attach this float 10" above the **Sump Pump** inlet.

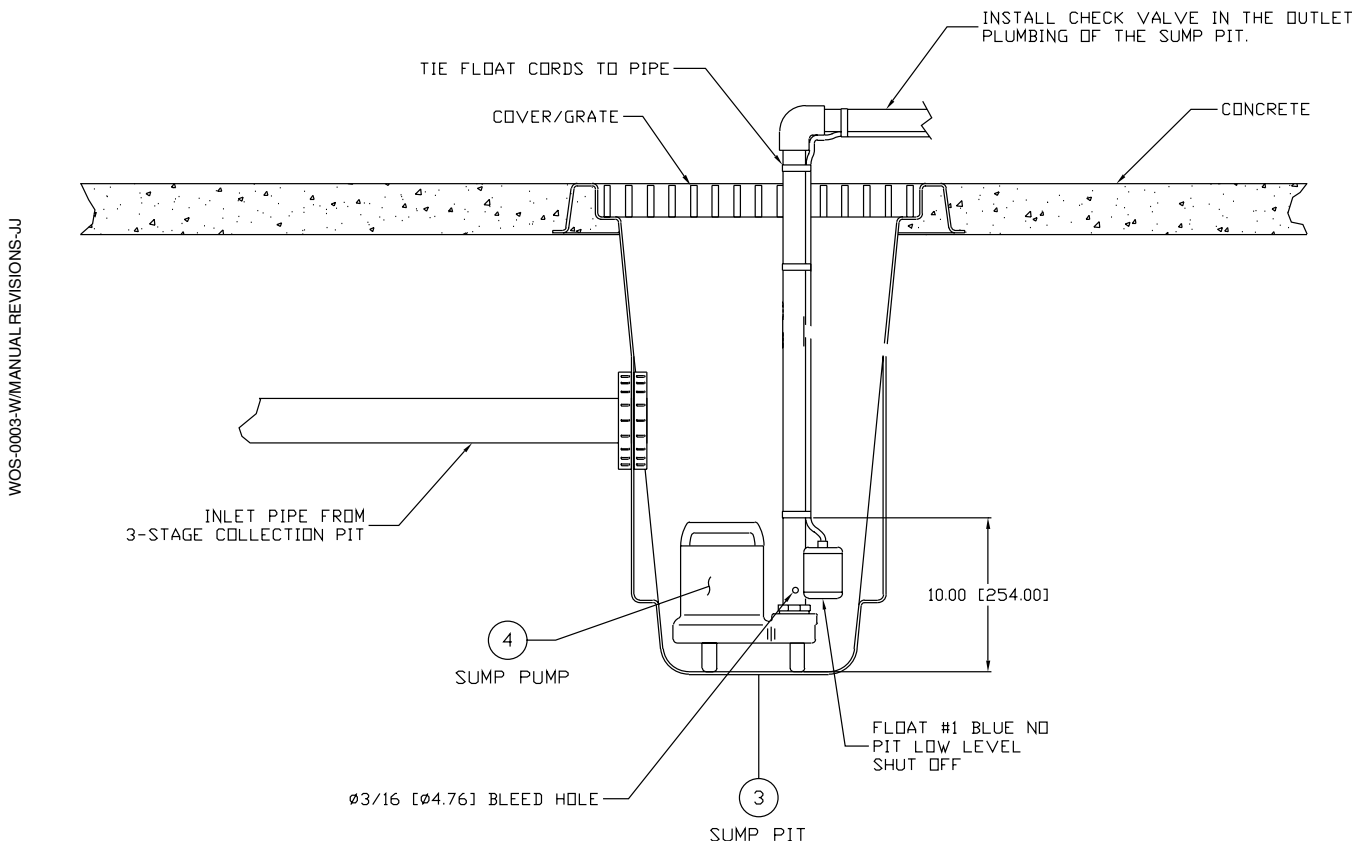

INSTALLATION



WARNING

RISK OF ELECTROCUTION! TO REDUCE THE RISK OF ELECTROCUTION, KEEP ALL CONNECTIONS DRY AND OFF THE GROUND.

8. A qualified electrician must hook up the electrical system.
 - a. Verify the electrical supply at the power source is off.
 - b. Be certain all switches on the **Control Panel** are in the "OFF" position.
 - c. Run water tight conduit
 1. From the **Sump Pump** and Floats to the **Control Panel**.
 2. From the local disconnect to the **Control Panel**. The electrician will need to drill holes in the **Control Panel** for the conduit.
 - d. Make connections to the terminal strips as shown in the wiring diagram on the following page.
9. Make the following piping connections:
 - a. From a pressurized water supply to the **Fresh Water Makeup**.
 - b. From the **Outlet** to a pressure washer or garden hose.

NOTE: In most cases, you must have a permit to legally dispose recycled water.

230 VOLT 1 PHASE

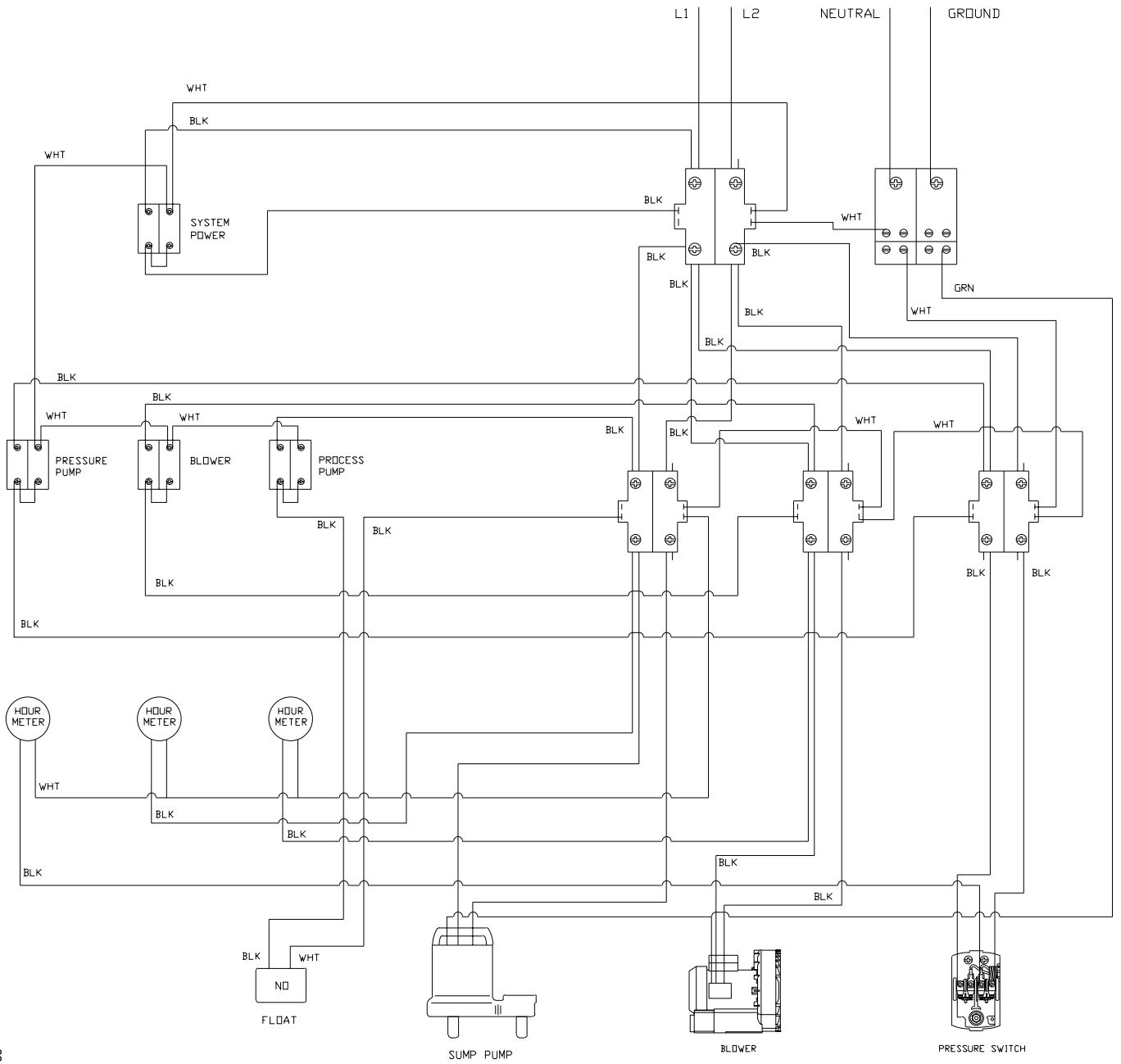

EDS-2-JJ

STOP

TO ENSURE YOUR WATER RECYCLE TREATMENT SYSTEM OPERATES SAFELY AND EFFICIENTLY, COMPLETE THE PRE-OPERATION CHECKLIST BEFORE PROCEEDING.

PRE-OPERATION CHECKLIST

Before proceeding, answer all the questions on this checklist.	YES	NO
CODES:		
1. Does the electrical wiring meet all codes?		
2. Does plumbing meet all codes?		
LOCATION:		
1. Is the unit located on a hard level surface free of flammable vapors, combustible dust, gases or other combustible materials?		
2. Is the unit located in a large ventilated area?		
ELECTRICAL:		
1. Is the unit properly grounded?		
2. Does the power supply, voltage and amperage match the data plate?		
PLUMBING:		
1. Is the plumbing sized correctly?		
2. Is the check valve installed near the Sump Pump ?		
3. Are all unions tightened?		
GENERAL:		
1. Have all operators using this unit read and understood this entire manual?		
2. Has the unit been installed by qualified service people who followed the instructions listed in this manual?		

IF "NO" WAS MARKED TO ANY OF THESE QUESTIONS, CORRECT THE SITUATION BEFORE OPERATING.

PREPARATION

PRESTART PROCEDURES:

1. Position the valves on the Biological Recycling System in the "Start-up Mode".
 - Blower Valve** : Turn completely closed. All air should be forced into diffusers.
 - Air Bleed Valve**: Turn valve open.
 2. Be certain all hoses are securely connected.
 3. Be certain the incoming air tube to the **Blower** is not obstructed.
 4. Be certain all switches on the **Control Panel** are in the "OFF" position.
 5. Turn on the power supply.
-

START-UP:

1. Ensure water supply is turned on and the **Biological System** is filling with water.
2. Turn on the **Sump Pump Switch**. Water will flow into the **Biological System**. The **Sump Pump** will automatically turn off when the **Biological System** is full.
3. Ensure the **Blower Valve** is completely closed, then turn on the **Blower Switch**. Air should be releasing from the four diffusers in each chamber. Bubbles should appear at the surface corresponding to each diffuser. If a visual check indicates one of the diffusers is not working, review Troubleshooting. Do not proceed until all diffusers are working.
4. Adjust the **Blower Valve** until the surface air bubbles are similar to a rolling boil.
5. When the **Product Tank** is full, prime the **Transfer Pump** by opening the valve to the **Cartridge Filter**.
6. Turn on the **Pressure Pump Switch** to allow water to flow into the **Pressure Tank**.
7. Open the Air Bleed Valve on the Cartridge Filter to allow water to flow into the Cartridge Filter.
8. Air will release from the **Air Bleed Valve** as the **Cartridge Filter** fills. Close the **Air Bleed Valve** when water begins to exit from it. This indicates the **Cartridge Filter** is filled. For optimum efficiency, occasionally open the **Air Bleed Valve** while the **Transfer Pump** is operating to relieve any air buildup.
9. Water is now completely cycled in the system and ready to be used at the manifold.
10. Slightly open the **Recirculation Valve** to ensure approximately one GPM of water is being returned from the **Product Tank** to the first tank.
11. Operate the **Biological System** for one hour before adding Mi-T-M microbes.

OPERATION

ADDING MICROBES:

1. Allow the Biological Recycling System to run for one hour before adding the first inoculation of microbes.
 - a. Open and pour four 500mL containers of the Mi-T-M prepackaged microbes into the first chamber of the Biological System.
2. Begin your normal cleaning operation.
3. Continue inoculations on a weekly basis to ensure the Bio-System is operating at optimum efficiency.
4. Monitor the system closely the first few days to ensure smooth operation. See Troubleshooting if problems occur.

The Mi-T-M microbes are most active and effective when the water temperature is between 70°F and 100°F. For climates where freezing temperatures are experienced, the Biological System should be enclosed in a heated room.

MAINTENANCE

ROUTINE MAINTENANCE:

1. Pits should be kept free from large amounts of sludge.
 2. Mi-T-M microbes, (four 500 mL bottles), should be added to the system each 30 days to ensure a healthy colony growth in the Biological System. The media pack should feel "slimey" to the touch when the microbe colony is established.
 3. The pH of the water should not be lower than 5.5 or higher than 8.5 at any given time.
 4. If soap is necessary for washing, the soap should be of a neutral pH (approximately 7).
 5. When the water flow decreases significantly, the cartridge filter should be cleaned using a garden hose or pressure washer.
-

WINTERIZING:

Mi-T-M does not advise operating your Bio-System in an area where the temperature falls below 34°F/1°C. Temperatures below 34°F/1°C will kill the microbe colony. If temperatures fall below 34°F/1°C, you can protect your Biological Recycling System by draining all water from the system.

1. Drain the **Cartridge Filter**.
2. Turn all switches on the **Control Panel** to the OFF position and disconnect power to the **Control Panel**.
3. Open the check valve near the **Sump Pit** and drain the water transport line. Remove the **Sump Pump** from the **Sump Pit**.
4. Open the Cartridge Filter Drain Valve 5 and open the **Air Bleed Valve**. Break the unions on each side.
5. Remove the drain plug from the **Transfer Pump**.
6. Remove the drain plugs from the **Biological System**, clean the tank and wipe down the system.
7. Store all chemicals at room temperature.

TROUBLESHOOTING

SYMPTOM	PROBABLE CAUSE	REMEDY
<i>ELECTRICAL</i>		
No power at Control Panel .	Power failure to Control Panel .	Check circuit breaker at power source or contact your local distributor.
Power Indicator Light is OFF.	Blown fuses inside Control Panel on step down transformer.	Check fuses, replace if necessary. If fuses are OK, contact your distributor.
<i>SUMP PUMP</i>		
Sump Pump will not run.	Floats are not adjusted correctly in the Sump Pit .	Readjust.
	Not enough water in the Sump Pit .	Add water to the Sump Pit .
	Float 1 is defective.	Replace.
	Level Limit Switch in the Separator Tank has flipped up.	Push Level Limit Switch down, or remove excess water in the Separator Tank .
	Circuit overload/breaker has tripped.	Reset breaker or replace fuse at power source.
	Motor overload.	Allow motor to cool. Motor will automatically restart when cool.
	Motor is defective.	Replace motor.
Sump Pump motor starts and stops frequently.	This is a common occurrence on initial start-up while pits are filling.	Allow pits to fill.
	Excessive water flow to reclaim unit.	Turn valve clockwise to reduce flow.
	Sump Pump impeller is clogged.	Disconnect power and unclog impeller.
	Motor overload.	Allow motor to cool. Motor will automatically restart when cool.
	Sump Pit is not large enough.	Expand size of pit.
Sump Pump runs, but there is little or no water discharge.	Strainer basket in Sump Pump is clogged.	Clean, repair or replace.
	Water level is below pump inlet.	Ensure Float 1 is not caught in plumbing.
	There is an air lock in the Sump Pump .	Manually fill the inlet pipe with water. Turn the Sump Pump on and off several times.
	Low voltage.	Ensure wire size is capable of handling the rated amperage of the unit. If wire size is correct, contact your distributor.
Sump Pump will not turn off.	Clogged impeller or worn pump parts.	Contact your distributor.
	Defective switch inside Float 1.	Replace.
	Pump is air locked.	Cycle pump in one minute increments several times to clear air from pump. If system includes a check valve, a 3/16" hole should be drilled in the discharge pipe approximately 2" above the discharge connections.

TROUBLESHOOTING

SYMPTOM	PROBABLE CAUSE	REMEDY
BIO-SYSTEM TANK		
Water will not flow into the Bio-System Tank .	Sump Pump is not turned on.	Move Sump Pump Switch to "ON"
	Circuit breaker has tripped or is "OFF".	Reset or turn breaker "ON".
	Dirt is lodged in the pit check valve.	Clean.
	Sump Pump impeller is clogged.	Disconnect power and clean.
	Lines or valves contain frozen water.	Allow to thaw. Inject with warm water if necessary.

TRANSFER PUMP

Transfer Pump will not run.	Transfer Pump Switch is off.	Turn switch on.
	Circuit overload/breaker has tripped.	Reset breaker or replace fuse.
	Motor overload.	Allow motor to cool. Motor will automatically restart when cool.
	Transfer Pump Switch is malfunctioning.	Replace switch.
Transfer Pump runs but there is no water discharge OR Transfer Pump cycles excessively.	Pump sucking air.	Eliminate leaks and tighten all connections on intake line.
	Check valve is leaking or stuck in closed position.	Clean or replace as necessary.
	Lines or valves contain frozen water.	Allow to thaw. Inject with warm water if necessary. Ensure the Sump Pit remains above freezing.
	Pump impeller is obstructed.	Contact your local distributor.
	Pump motor is operating below maximum RPM.	Contact your local distributor.
Transfer Pump is hot or turns off.	Low voltage.	Ensure wire size is capable of handling the rated amperage of the unit. If wire size is correct, contact your local distributor.
	Motor overload.	Allow motor to cool. Motor will automatically restart when cool.

SHAFT SEALS

Water is leaking at Transfer Pump .	Damaged stationary shaft seal.	Seal ran dry. Ensure seal chamber is filled with liquid.
Short seal life.	Unexpected temperature and chemical usage.	Replace.

TROUBLESHOOTING

SYMPTOM	PROBABLE CAUSE	REMEDY
ODOR		
Excessive odor in water system.	Not enough microbes in the system to maintain water balance.	Increase the microbe inoculation.
	Too much waste water for microbes to maintain bio-system.	Use of chemical injection may be necessary.
	****Water remains dormant in the system too long causing bacteria buildup.	The Biological System and Blower should be on 24 hours per day.

WATER FLOW

Air shoots from Water Outlet.	This is a common occurrence while pump is priming.	Air will stop shooting from the water outlet when pump is primed.
	Transfer Pump is sucking air at suction inlet.	Eliminate leaks or tighten connection.

STATEMENT OF WARRANTY

Mi-T-M warrants all parts (except those referred to below) of your new Biological Recycling System to be free from defects in materials and workmanship during the following periods:

For One (1) Year from the date of original purchase:

Defective parts not subject to normal wear and tear will be repaired or replaced at Mi-T-M's option during the warranty period. In any event, reimbursement is limited to the purchase price paid.

EXCLUSIONS

1. The motor is covered under separate warranty by its respective manufacturer and is subject to the terms set forth therein.
2. Normal wear parts:

Seals	Filters	Gaskets
O-rings	Packings	Pistons
Valve Assembly	Brushes	Microbes
Sensors		
3. Parts damaged due to:
 - normal wear, misapplication, modifications/alterations, abuse,
 - operation at other than recommended speeds, pressures or temperature,
 - the use of caustic liquids,
 - chloride corrosion or chemical deterioration,
 - fluctuations in electrical or water supply,
 - operating unit in an abrasive, corrosive or freezing environment.
4. Parts damaged by failure to follow recommended:
 - installation, operating and maintenance procedures.
5. This warranty does not cover the cost of:
 - normal maintenance or adjustments,
 - labor charges,
 - transportation charges to Service Center,
 - freight damage.
6. The use of other than genuine Mi-T-M parts will void warranty.

Parts returned, prepaid to Mi-T-M's factory or to an Authorized Service Center will be inspected and replaced free of charge if found to be defective and subject to warranty. There are no warranties which extend beyond the description of the face hereof. Under no circumstances shall Mi-T-M bear any responsibility for loss of use of the unit, loss of time or rental, inconvenience, commercial loss or consequential damages.

